

# Model 960

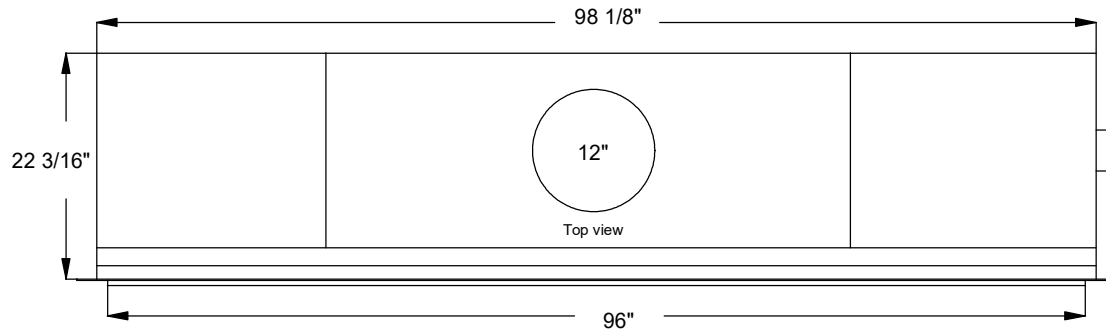

Minimal required lip  
5/8" from back of flange  
to face of fireplace

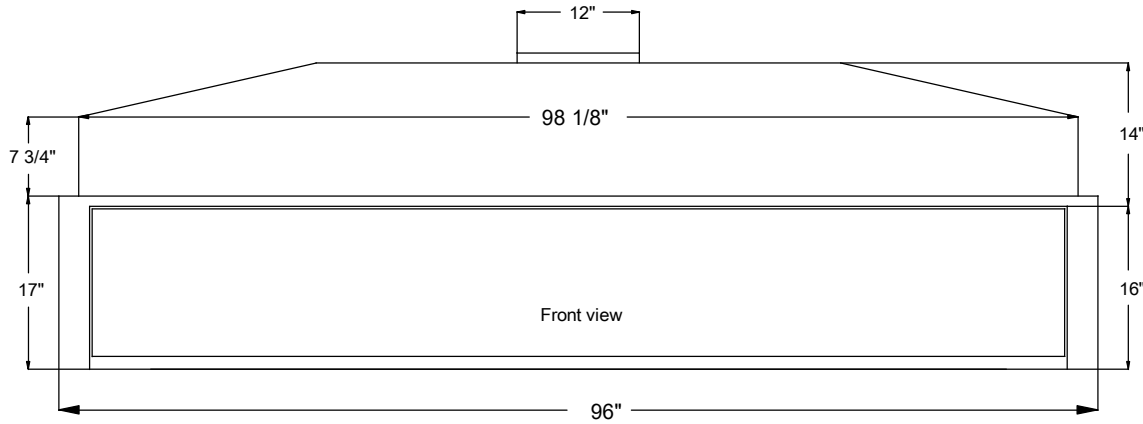