

Model 840

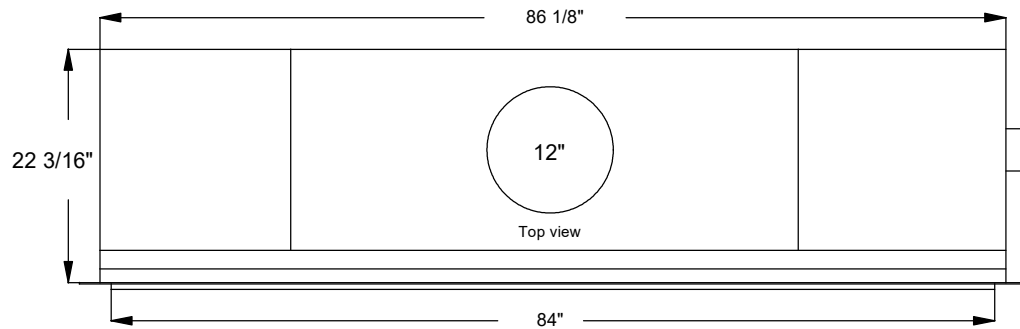

Minimal required lip
5/8" from back of flange
to face of fireplace

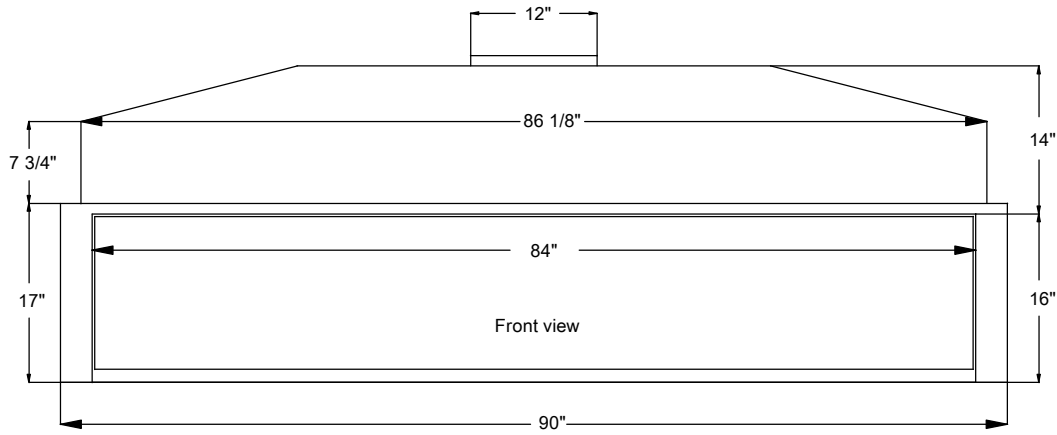