

Model 540

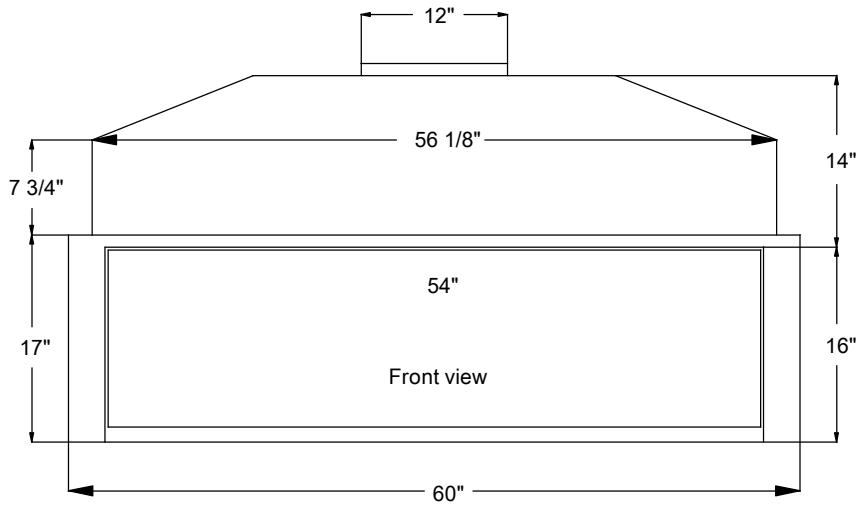

Minimal required lip
5/8" from back of flange
to face of fireplace

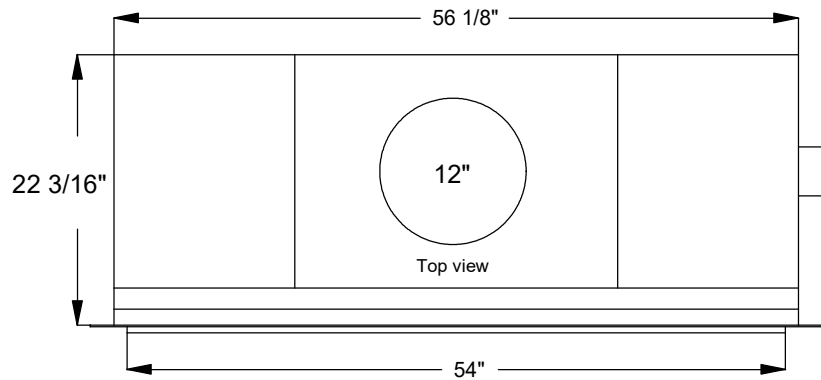

4" fresh air intake
protrudes 2" outside

