

Model 300

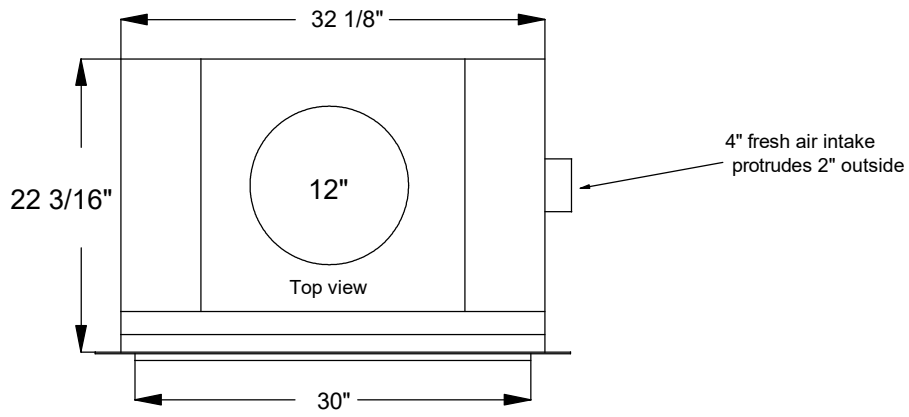

Minimal required lip
5/8" from back of flange
to face of fireplace

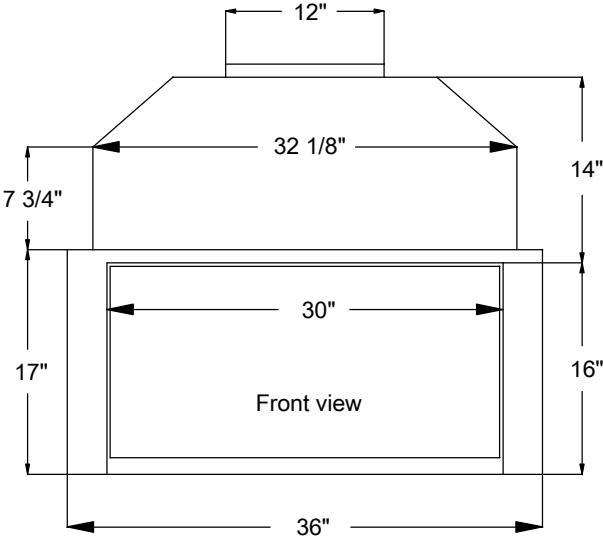