

# Model1080

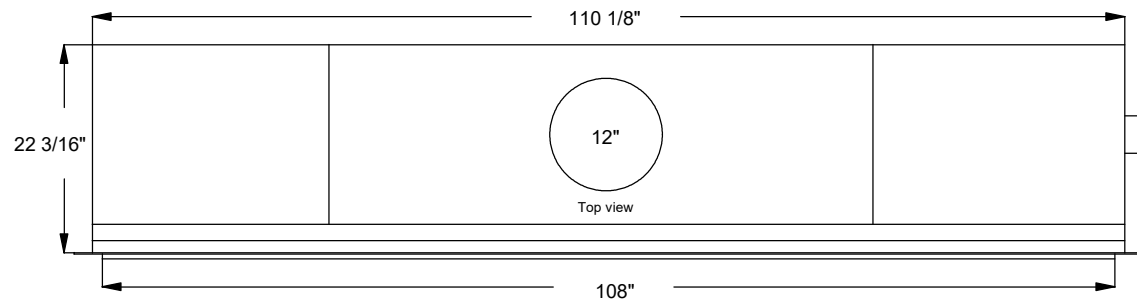

Minimal required lip  
5/8" from back of flange  
to face of fireplace

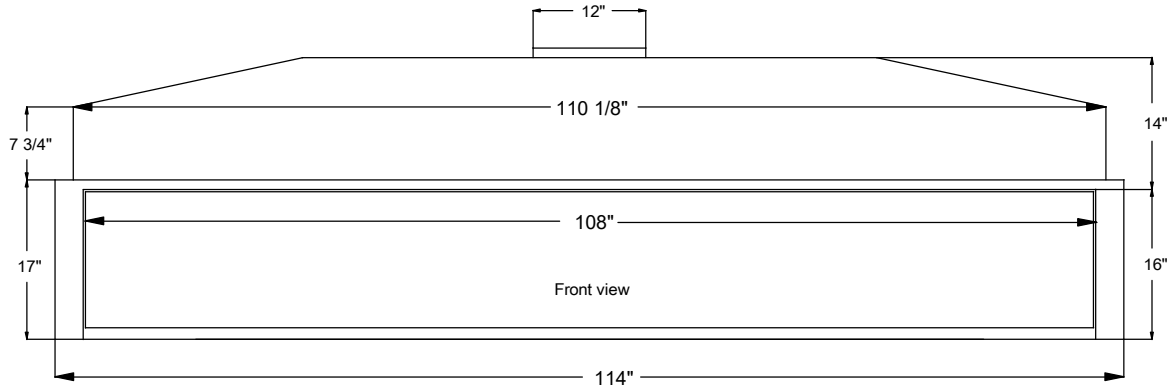